

PLURALUCE® BEGHELLI PRAEZISA

IP20



SICURO® SELV



24V DC ±20%
Ta: -20+40°C

SICURO®



176 + 276V DC
230V AC 50/60Hz
Ta: -20+40°C

Beghelli
PRAEZISA

334000016

E-Mail: Kontakt@beghelli.de - Internet: www.beghelli.de



	24V DC W		OPTIC
32042	3,8W	1 LED	

	216V DC W		OPTIC
31040	4,1W	1 LED	

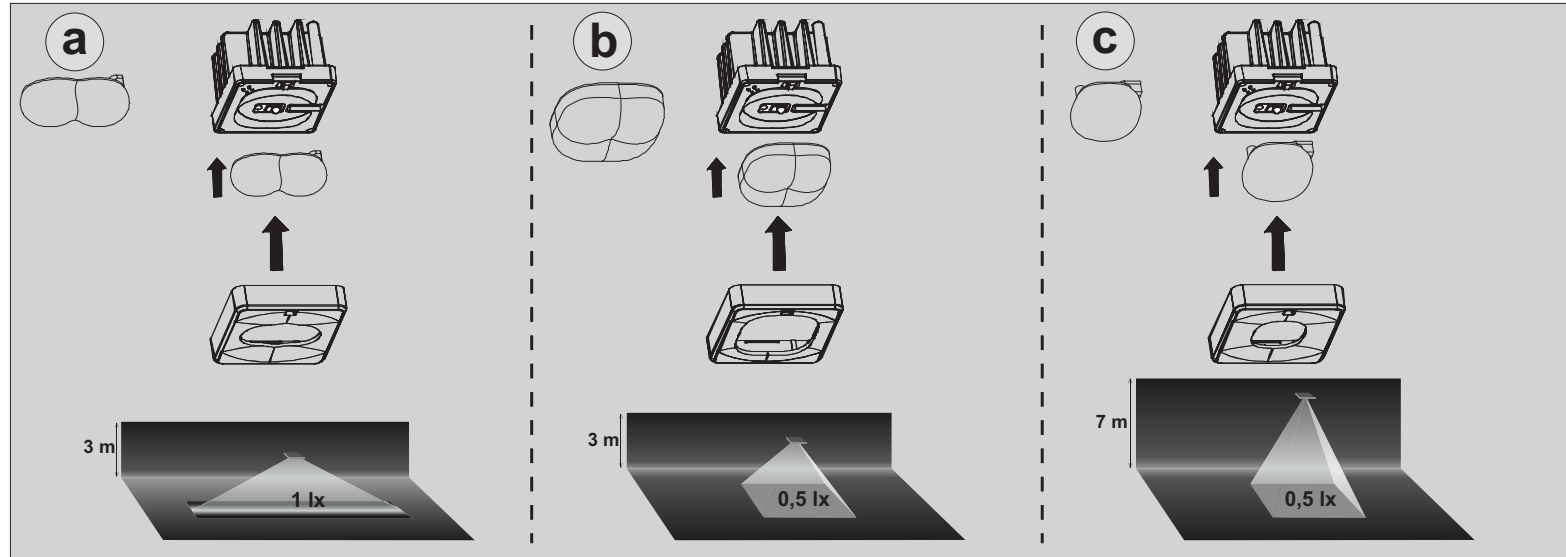
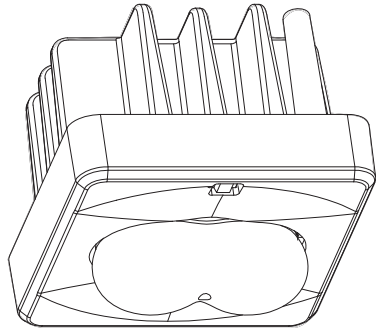

A

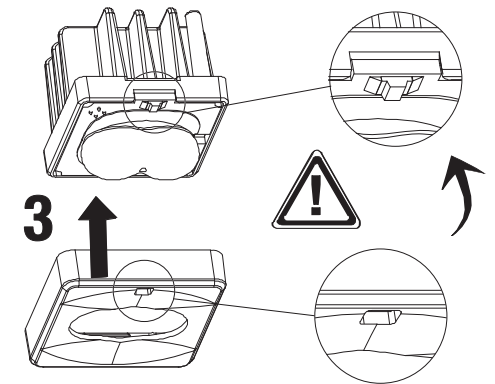
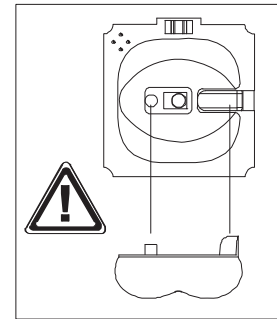
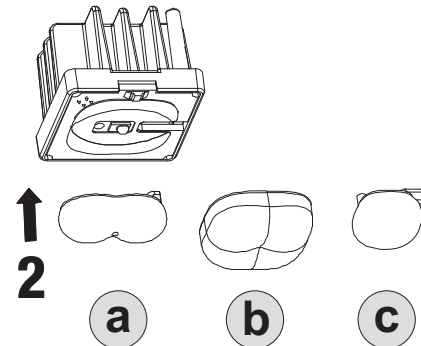
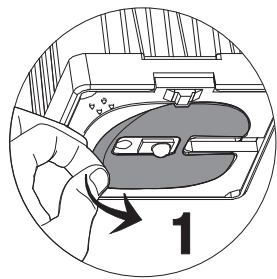

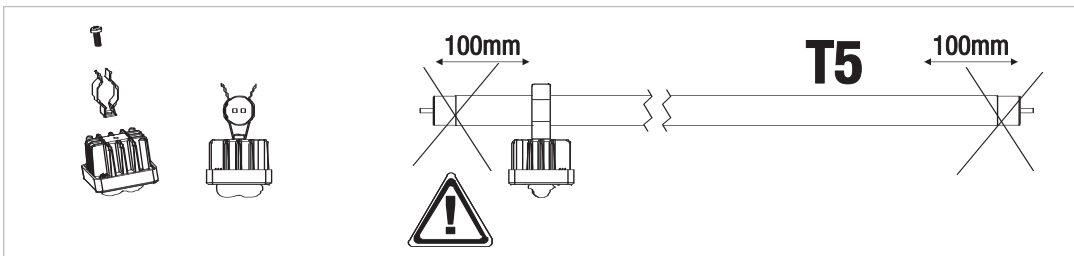
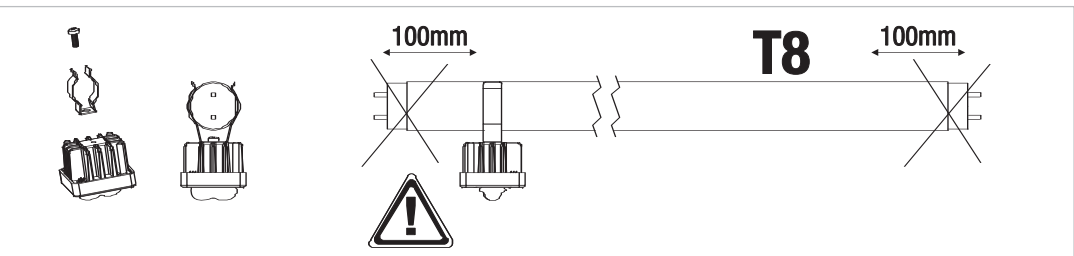
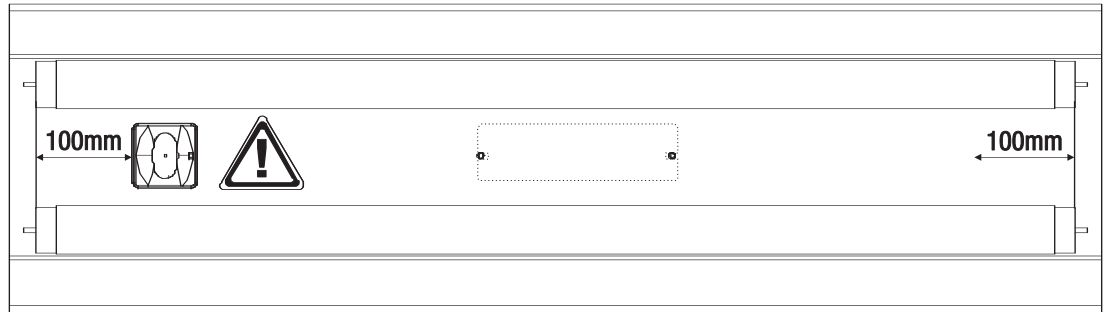
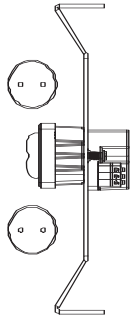
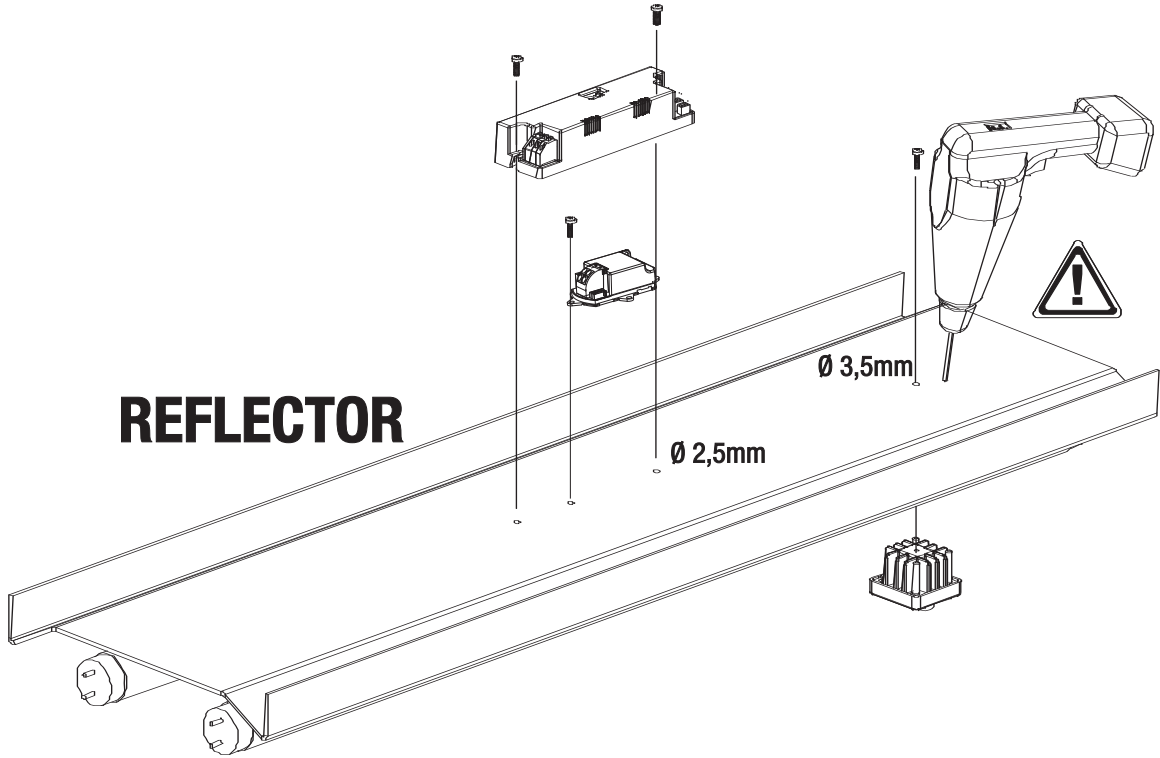
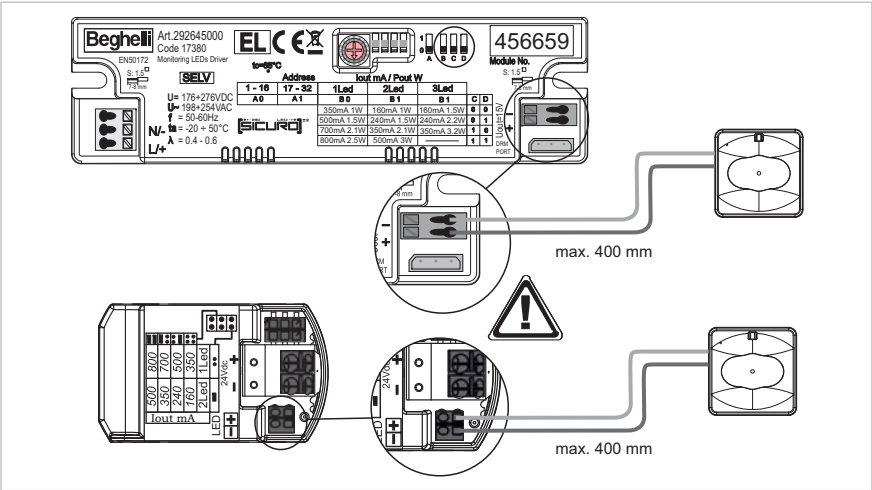
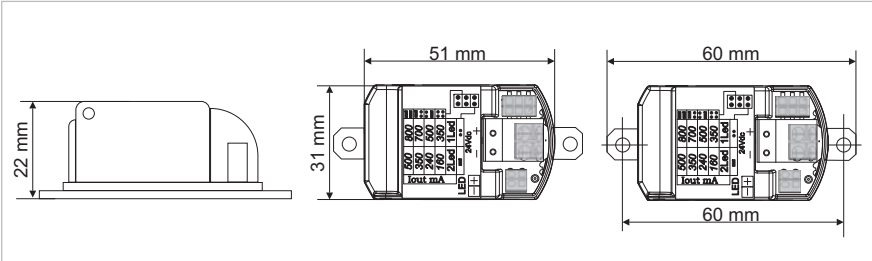
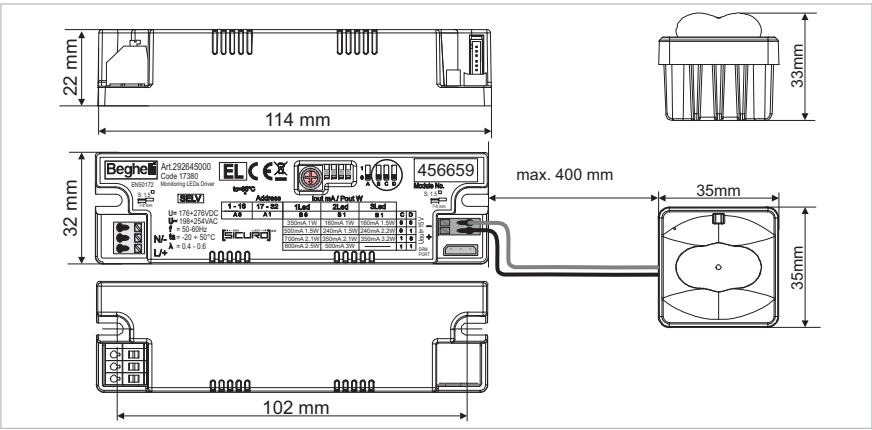

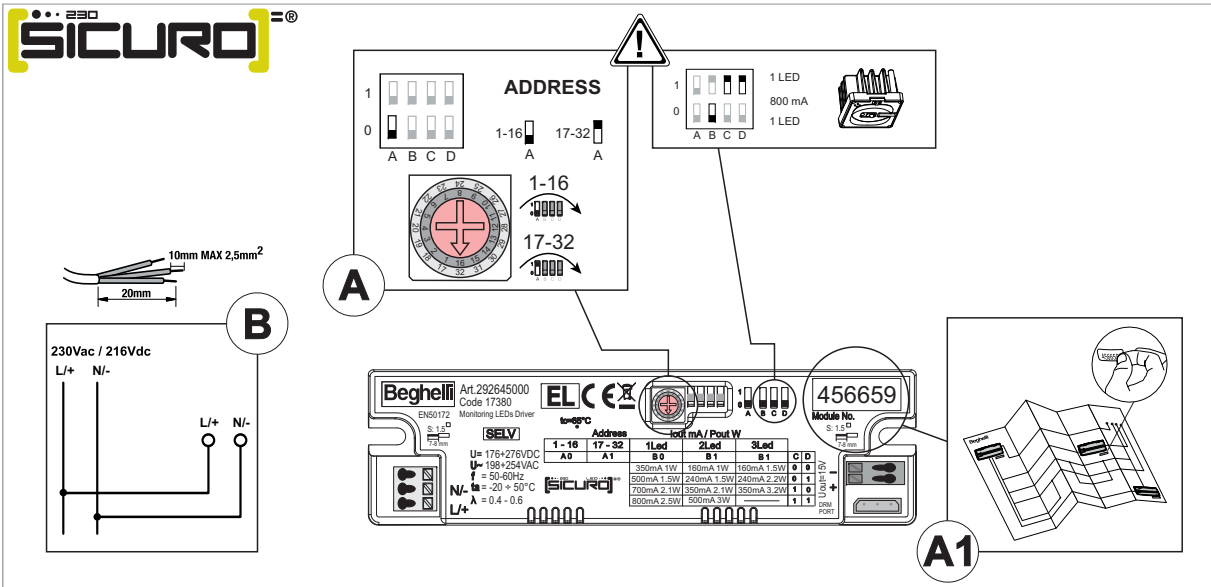

APPARECCHI PER SEGNALETICA E ILLUMINAZIONE DI EMERGENZA

L'apparecchio consente di centralizzare l'accensione e lo spegnimento integrando funzioni di diagnosi. L'apparecchio è dotato di un selettore rotativo per l'indirizzamento (Fig. A) - (solo per Sicuro230). In alternativa l'acquisizione in centrale può essere effettuata automaticamente tramite il riconoscimento dell'ID (Fig. A1).

SCHEMI DI COLLEGAMENTO:

Collegamenti rete (L/+; N/-) rispettare le polarità (Fig. B).

CODIFICA:

Indirizzi: da 1 a 16 - (Fig. A).

Indirizzi: da 17 a 32 - (Fig. A).

AVVERTENZE - GARANZIA

- Questo apparecchio dovrà essere destinato solo all'uso per il quale è stato costruito.

Ogni altro uso è da considerarsi improprio e pericoloso.

- La sorgente LED è di tipo non sostituibile.

Per eventuali riparazioni rivolgersi ad un centro di assistenza Tecnica autorizzato e richiedere l'utilizzo di ricambi originali.

Il mancato rispetto di quanto sopra può compromettere la sicurezza dell'apparecchio.

- Per le modalità di intervento in garanzia contattare il Numero Verde 800 626626 o il Rivenditore Autorizzato.

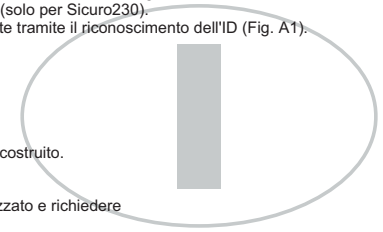

NOTLEUCHTE FÜR RETTUNGSZEICHEN UND FLUCHTWEGE

Die Leuchte ermöglicht ein zentralisiertes Schalten sowie Diagnosefunktionen.

Die Leuchte ist mit einem Drehschalter zur manuellen Adressierung ausgestattet (Abb. A) - (nur für Sicuro230).

Alternativ kann die Adressierung automatisch über die Zentrale durch Einlesung der ID erfolgen (Abb. A1).

ANSCHLUSSSCHEMA:

Netzanschlüsse (L/+; N/-) und Polung berücksichtigen (Abb. B).

KODIERUNG:

Adressen: von 1 bis 16 - (Abb. A).

Adressen: von 17 bis 32 - (Abb. A).

WARNUNGEN - GARANTIE

- Die Leuchte ist ausschließlich für den Zweck, für den sie hergestellt wurde, zu verwenden.

Jede davon abweichende Verwendung wird als nicht zweckentsprechend und somit als gefährlich angesehen.

- Die LED-Quelle ist nicht auswechselbar.

Für eventuelle Reparaturen autorisiertes Service-Center kontaktieren, um Originalersatzteile anzufordern.

Das Nichteinhalten der oben genannten Bestimmungen kann die Sicherheit der Leuchte gefährden.

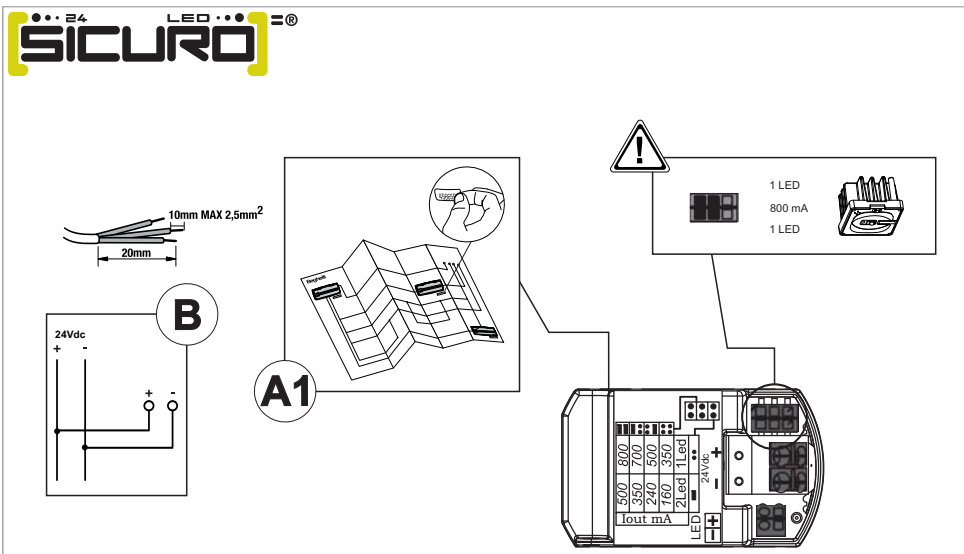
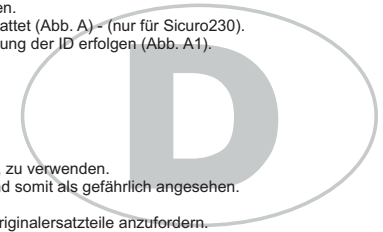

EMERGENCY LUMINAIRE FOR EXIT SIGNS AND ESCAPE ROUTES

The luminaire allows a centralised switching as well as diagnostic functions.

The luminaire is equipped with a rotary switch for manual addressing (Fig. A) - (for Sicuro230 only).

Alternatively the addressing can be done automatically over the central by read-in of the ID (Fig. A1).

WIRING DIAGRAM:

Consider mains connections (L/+; N/-) and polarity (Fig. B).

CODING:

Addresses: from 1 to 16 - (Fig. A).

Addresses: from 17 to 32 - (Fig. A).

WARNINGS - GUARANTEE

- The luminaire shall be used exclusively for the purpose for which it has been designed.

Any other use is considered improper and therefore as dangerous.

- The LED source is not replaceable.

For any repairs possibly required contact an authorised service center to require original spare parts.

The non-compliance of the abovementioned regulations may harm the safety of the luminaire.

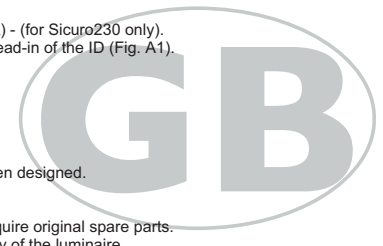

NOUZOVÁ SVÍTIDLA PRO NOUZOVÉ ZNAČENÍ A ÚNIKOVÉ CESTY

Svítlidlo umožňuje centrální spínání i diagnostické funkce.

Svítlidlo je vybaveno spínačem pro manuální adresování (Obr. A) - (pouze pro Sicuro230)

Případně může být adresování provedeno automaticky přes centrální jednotku a to načtením ID (Obr. A1).

SCHEMA ZAPOJENÍ:

S ohledem na síťové připojení (L/+; N/-) a polaritu (Obr. B).

KÓDOVÁNÍ:

Adresy: od 1 do 16 - (Obr. A).

Adresy: od 17 do 32 - (Obr. A).

UPOZORNĚNÍ - ZÁRUKA

Toto svítlidlo může být použito pouze k účelu, pro nějž bylo vyrobeno.

Jakékoliv jiné použití bude považováno za nevhodné a tím také nebezpečné.

- LED zdroj není vyměnitelný.

Pro případné opravy se obraťte na autorizované servisní středisko, které používá pouze originální náhradní díly.

Nerespektování výše uvedených podmínek může ohrozit bezpečnost svítlidla.

