

# ORIENTAČNÍ SVÍTIDLA

## FORMULA65



**Nouzové orientační svítidlo s vysokou úrovní krytí.** Ploché těleso s čirou, konvexně zakřivenou optickou vyzařovací plochou a čirým vysoce leštěným krytem a zaklapávacími uzavíracími sponami. Tok světla je usměřován plastovým reflektorem. Jednostranné značení únikových cest (viditelnost 25 m) je poskytované samolepicími piktogramy, oboustranné značení únikových cest (viditelnost 30 m) je zajištěno vkládacím difuzérem s piktogramem. Verze Formula 65 Extreme je dodávána s vyšším tělesem.

Dostupné jsou verze pro přisazenou nástěnnou a stropní montáž, nebo s příslušenstvím pro vestavnou nástěnnou a stropní montáž, závěsnou lankovou nebo tyčovou montáž a vlnkovou montáž na konzolu (výložník).

### MOŽNOSTI MONTÁŽE

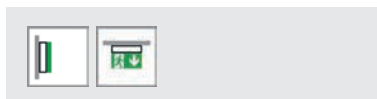

### MOŽNOSTI MONTÁŽE s PŘÍSLUŠENSTVÍM



### TECHNICKÁ DATA

**Těleso:** polykarbonát, bílý (RAL 9003)  
**Kryt:** polykarbonát, průhledný  
**Difuzér:** methakrylát, průhledný  
**Piktogram:** methakrylát, tištěný  
**Světelný kryt:** methakrylát, tištěný (Kit)  
**Reflektor:** polykarbonát, bílý

**Pokles světelného toku  $L_{80}B_{50}$ :** 50 000 h  
**Stabilita barvy světla:** 3 SDCM



### S VLASTNÍM NAPÁJENÍM

**Síťové napájení:** 198–254 V / 50 Hz  
**Upřesnění:** stále svítící (SA) nebo nouzově svítící (SE)  
**Teplota okolí:** LTO: -20 °C až +50 °C  
 klasická: 0 °C až +40 °C  
**Třída ochrany:** II

### DECENTRALIZOVANÉ NAPÁJENÍ

**Napájení z baterie:** 24 V ±20% DC  
**Síťové napájení:** 24 V ±20% DC  
**Teplota okolí:** -20 °C až +40 °C  
**Třída ochrany:** III

### CENTRÁLNÍ NAPÁJENÍ

**Napájení z baterie:** 176–276 V  
**Síťové napájení:** 198–254 V / 50 Hz  
**Teplota okolí:** -20 °C až +40 °C  
**Třída ochrany:** II

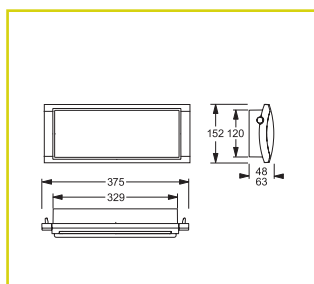

Přisazená nástěnná montáž

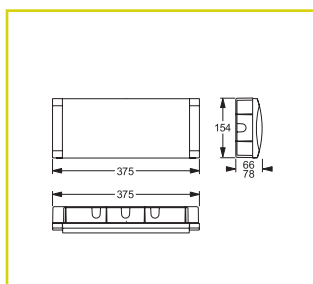

Vestavná nástěnná montáž

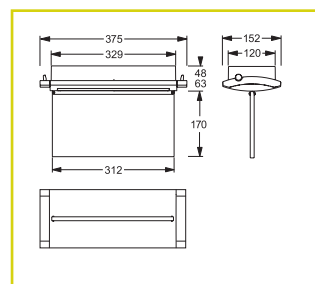

Přisazená stropní montáž

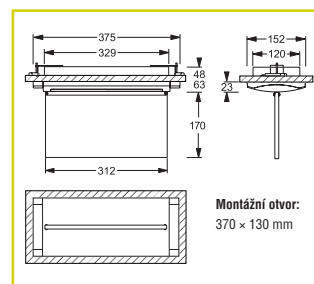

Vestavná stropní montáž

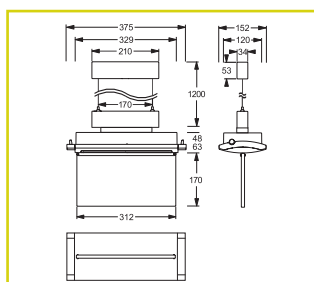

Lankový závěs

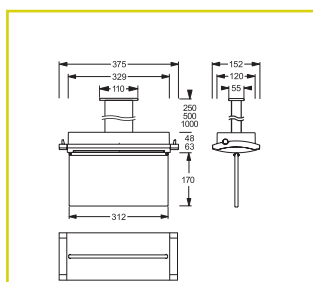

Trubkový závěs

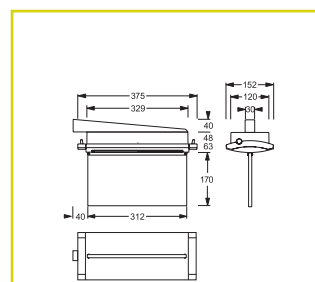

Montáž na výložník



## S VLASTNÍM NAPÁJENÍM

Autotest Kód	LOGICA Kód	LOGICA FM Kód					
--------------	------------	---------------	--	--	--	--	--

Přisazená nástěnná montáž (jednostranný piktogram / osvětlení prostor), přisazená nebo vestavná stropní montáž, závěsná montáž a montáž na výložník (oboustranný piktogram / osvětlení prostor)<sup>1</sup>

19296	19296+15036	19296+15037	25 m	22	1 h	2× LTO 4,8 V / 1,2 Ah	13 VA
19296-3 h	19296-3 h+15036	19296-3 h+15037	25 m	22	3 h	2× LTO 4,8 V / 1,2 Ah	13 VA
19296-8 h	19296-8 h+15036	19296-8 h+15037	25 m	22	8 h	2× LTO 4,8 V / 1,2 Ah	13 VA

## CLASSIC S VLASTNÍM NAPÁJENÍM

Autotest Kód	LOGICA Kód	LOGICA FM Kód						
--------------	------------	---------------	--	--	--	--	--	--

Přisazená nástěnná montáž (jednostranný piktogram / osvětlení prostor), přisazená nebo vestavná stropní montáž, závěsná montáž a montáž na výložník (oboustranný piktogram / osvětlení prostor)<sup>1</sup>

R2436SA	19239	19245	25 m	22	1 h / 3 h	NiMH 3,6 V / 1,2 Ah	2× NiMH 3,6 V / 1,2 Ah	8,5 VA
---------	-------	-------	------	----	-----------	---------------------	------------------------	--------

Přisazená nebo vestavná nástěnná montáž (jednostranný piktogram), přisazená nebo vestavná stropní montáž, závěsná montáž a montáž na výložník (oboustranný piktogram), verze Extreme<sup>1</sup>

19270	19270	19276	25 m	22	1 h / 3 h	NiMH 3,6 V / 1,7 Ah	NiMH 3,6 V / 1,7 Ah	8 VA
-------	-------	-------	------	----	-----------	---------------------	---------------------	------

## SICURO<sup>LED</sup> DECENTRALIZOVANÉ NAPÁJENÍ

Sicuro24 Kód			
--------------	--	--	--

Přisazená nebo vestavná nástěnná montáž (jednostranný piktogram), přisazená nebo vestavná stropní montáž, závěsná montáž a montáž na výložník (oboustranný piktogram), verze Extreme<sup>1</sup>

32094	25 m	32	3,8 W
-------	------	----	-------

## SICURO<sup>LED</sup> CENTRÁLNÍ NAPÁJENÍ

Sicuro230 Kód				
---------------	--	--	--	--

Přisazená nebo vestavná nástěnná montáž (jednostranný piktogram), přisazená nebo vestavná stropní montáž, závěsná montáž a montáž na výložník (oboustranný piktogram), verze Extreme<sup>1</sup>

31124	25 m	32	8,3 VA / 4,1 W
-------	------	----	----------------

<sup>1</sup> Pro přisazenou nebo vestavnou nástěnnou montáž, závěsnou montáž a montáž na výložník, prosím objednejte příslušenství zvlášť

### Příslušenství – dodáváno včetně

Kód	Popis	
19044	sada piktogramů (dolů, doprava, doleva)	

### Příslušenství – nutno objednat zvlášť

Kód	Popis	
VD 25 m	VD 30 m	
29000	difuzér s piktogramem šipka nahoru	
E16040M-KIT-F65	difuzér s piktogramem šipka vlevo, vpravo	
E16041M-KIT-F65	difuzér s piktogramem šipka dolů	
E16042M-KIT-F65	difuzér s piktogramem šipka vlevo, vpravo, vpravo dolů	
E16043M-KIT-F65	difuzér s piktogramem šipka nahoru	
E16045M-KIT-F65	difuzér s piktogramem šipka vlevo, vpravo, vpravo nahoru	

### Příslušenství – nutno objednat zvlášť

Kód	Popis
VD 25 m	VD 30 m
F95943	F95943 adaptér pro závěsnou montáž
F95961	F95961 adaptér pro závěsnou montáž, verze Extreme
F95067	F95067 adaptér pro vlajkovou montáž
F95600	F95600 trubkový závěs, hranatý, 250 mm
F95601	F95601 trubkový závěs, hranatý, 500 mm
F95602	F95602 trubkový závěs, hranatý, 1 000 mm
F95057	F95057 adaptér pro přisazenou montáž
19045	19045 výložník (vlajková montáž)
F95942	F95942 kryt pro montáž na výložník do exteriéru
19040	19040 box pro vestavnou montáž do stěn
19048	19048 box pro vestavnou montáž do stěn, verze Extreme
19041	19041 box pro vestavnou montáž do stropu
19049	19049 box pro vestavnou montáž do stropu, verze Extreme