

# S-In-LED® SICURO - BEGHELLI PRAEZISA

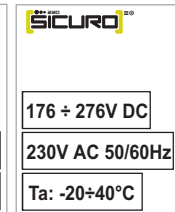

334000011

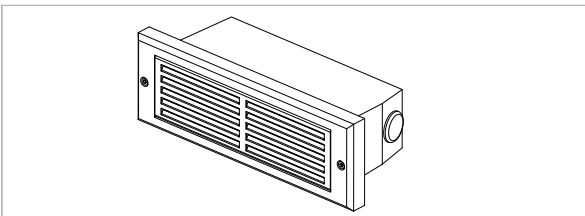

E-Mail: [Kontakt@beghelli.de](mailto:Kontakt@beghelli.de) - Internet: [www.beghelli.de](http://www.beghelli.de)

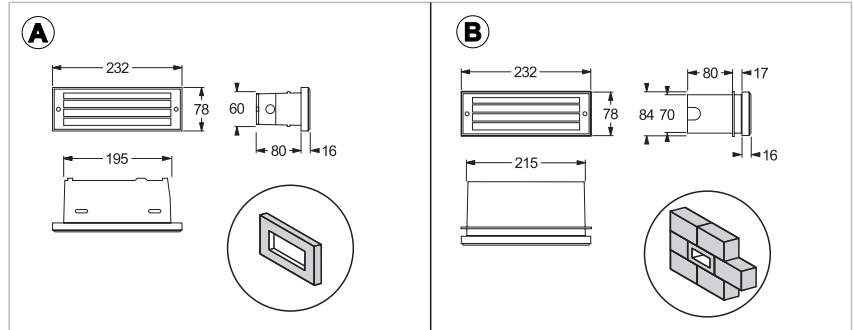

	24V DC W		UNI EN 1030 ▶		216V DC W		UNI EN 1030 ▶
32031	4,3W	3 LED	-	31031	4,5W	3 LED	-

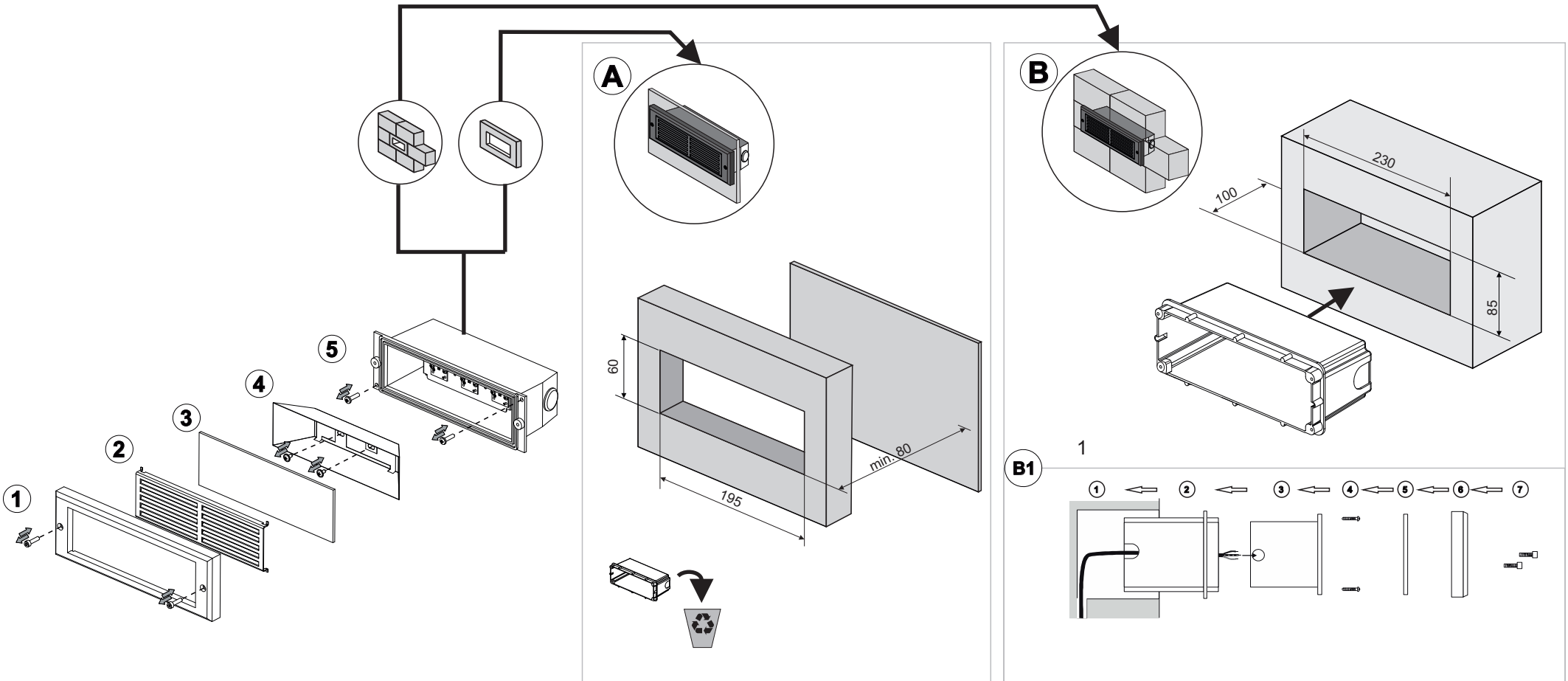

**SICURO** 230

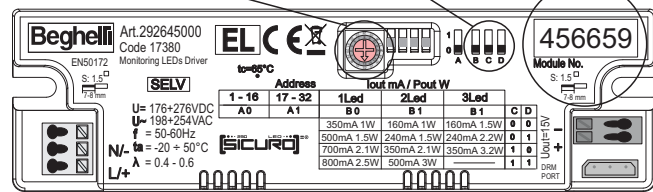
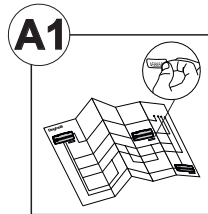
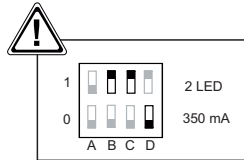
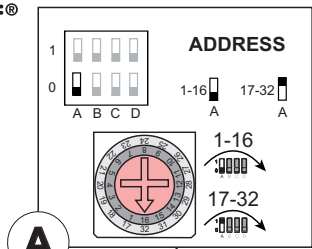
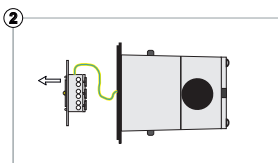
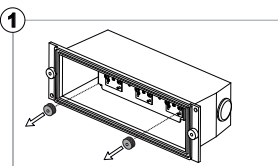
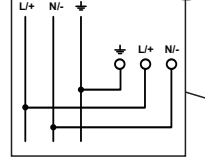
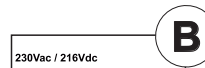
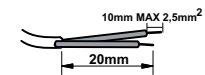

**APPARECCHI PER SEGNALETICA E ILLUMINAZIONE DI EMERGENZA**

L'apparecchio consente di centralizzare l'accensione e lo spegnimento integrando funzioni di diagnosi. L'apparecchio è dotato di un selettore rotativo per l'indirizzamento (Fig. A) - (solo per Sicuro230). In alternativa l'acquisizione in centrale può essere effettuata automaticamente tramite il riconoscimento dell'ID (Fig. A1).

**SCHEMI DI COLLEGAMENTO:**

Collegamenti rete (L+; N/-) rispettare le polarità (Fig. B).

**CODIFICA:**

Indirizzi: da 1 a 16 - (Fig. A).

Indirizzi: da 17 a 32 - (Fig. A).

**AVVERTENZE - GARANZIA**

- Questo apparecchio dovrà essere destinato solo all'uso per il quale è stato costruito.

Ogni altro uso è da considerarsi improprio e pericoloso.

- La sorgente LED è di tipo non sostituibile.

Per eventuali riparazioni rivolgersi ad un centro di assistenza Tecnica autorizzato e richiedere l'utilizzo di ricambi originali.

Il mancato rispetto di quanto sopra può compromettere la sicurezza dell'apparecchio.

- Per le modalità di intervento in garanzia contattare il Numero Verde 800 626626 o il Rivenditore Autorizzato.

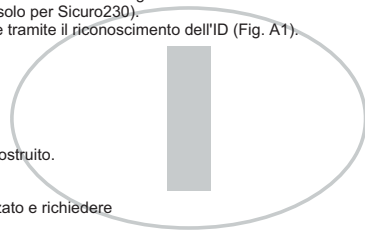

**NOTLEUCHE FÜR RETTUNGSZEICHEN UND FLUCHTWEGE**

Die Leuchte ermöglicht ein zentralisiertes Schalten sowie Diagnosefunktionen.

Die Leuchte ist mit einem Drehschalter zur manuellen Adressierung ausgestattet (Abb. A) - (nur für Sicuro230).

Alternativ kann die Adressierung automatisch über die Zentrale durch Einlesung der ID erfolgen (Abb. A1).

**ANSCHLUSSSCHEMA:**

Netzanschlüsse (L+; N/-) und Polung berücksichtigen (Abb. B).

**KODIERUNG:**

Adressen: von 1 bis 16 - (Abb. A).

Adressen: von 17 bis 32 - (Abb. A).

**WARNUNGEN - GARANTIE**

- Die Leuchte ist ausschließlich für den Zweck, für den sie hergestellt wurde, zu verwenden.

Jede davon abweichende Verwendung wird als nicht zweckentsprechend und somit als gefährlich angesehen.

- Die LED-Quelle ist nicht auswechselbar.

Für eventuelle Reparaturen autorisiertes Service-Center kontaktieren, um Originalersatzteile anzufordern.

Das Nichteinhalten der oben genannten Bestimmungen kann die Sicherheit der Leuchte gefährden.

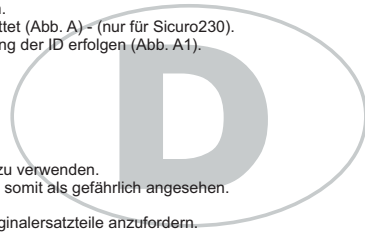

**EMERGENCY LUMINAIRE FOR EXIT SIGNS AND ESCAPE ROUTES**

The luminaire allows a centralised switching as well as diagnostic functions.

The luminaire is equipped with a rotary switch for manual addressing (Fig. A) - (for Sicuro230 only).

Alternatively the addressing can be done automatically over the central by read-in of the ID (Fig. A1).

**WIRING DIAGRAM:**

Consider mains connections (L+; N/-) and polarity (Fig. B).

**CODING:**

Addresses: from 1 to 16 - (Fig. A).

Addresses: from 17 to 32 - (Fig. A).

**WARNINGS - GUARANTEE**

- The luminaire shall be used exclusively for the purpose for which it has been designed.

Any other use is considered improper and therefore as dangerous.

- The LED source is not replaceable.

For any repairs possibly required contact an authorised service center to require original spare parts.

The non-compliance of the abovementioned regulations may harm the safety of the luminaire.

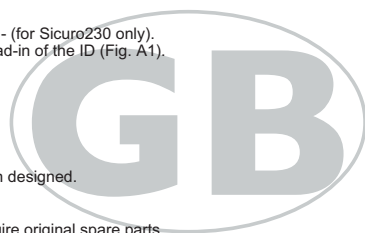

**SICURO** LED 24

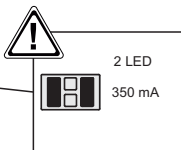
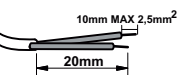
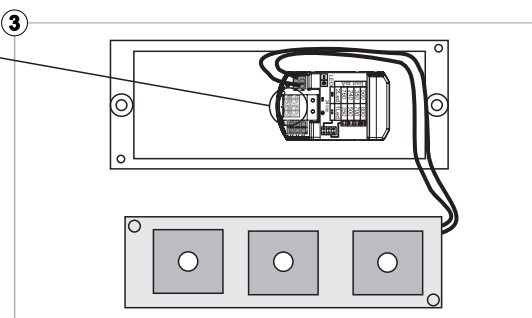
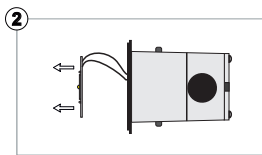
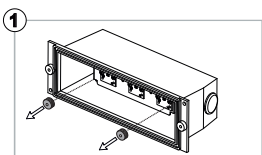
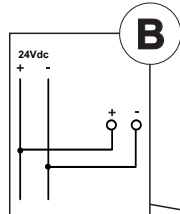
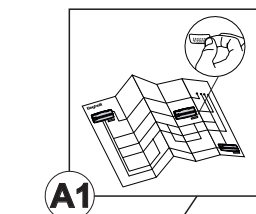

**NOUZOVÁ SVÍTLIDLA PRO NOUZOVÉ ZNAČENÍ A ÚNIKOVÉ CESTY**

Svítlidlo umožňuje centrální spínání i diagnostické funkce.

Svítlidlo je vybaveno spínačem pro manuální adresování (Obr. A) - (pouze pro Sicuro230)

Případně může být adresování provedeno automaticky přes centrální jednotku a to načtením ID (Obr. A1).

**SCHEMA ZAPOJENÍ:**

S ohledem na síťové připojení (L+; N/-) a polaritu (Obr. B).

**KÓDOVÁNÍ:**

Adresy: od 1 do 16 - (Obr. A).

Adresy: od 17 do 32 - (Obr. A).

**UPOZORNĚNÍ - ZÁRUKA**

Toto svítidlo může být použito pouze k účelu, pro nějž bylo vyrobeno.

Jakékoli jiné použití bude považováno za nevhodné a tím také nebezpečné.

- LED zdroj není vyměnitelný.

Pro případné opravy se obraťte na autorizované servisní středisko, které používá pouze originální náhradní díly.

Nerespektování výše uvedených podmínek může ohrozit bezpečnost svítidla.



Beghelli Präzisa GmbH  
Lanterstraße 34  
D-46539 Dinslaken  
Germany

