

# Lens Fila



- Continuous row with high luminous flux.
- Emission-controlled multi-lens system.
- Feed-through wiring and quick access to the terminal block.

## Applications

Services, retail

## Characteristics

### Power supply

**SD** 93÷265VAC 50÷60Hz 176÷250VDC

**ED** 230VAC ±10% 50Hz

**Power supply - MTBF at 25°C** 80,000h

**Luminous flux retention at 25°C**

>60,000h (L80B20)

**Colour stability** 3 SDCM

**Mounting** ceiling, suspended

**Housing** Steel painted RAL 9003

**Optics** Clear PMMA

**Compliance** EN60598-1, EN60598-2-1, EN 60598-2-22, EN 62471 (biological risk-free) 2014/53/EU

\* Single luminaire

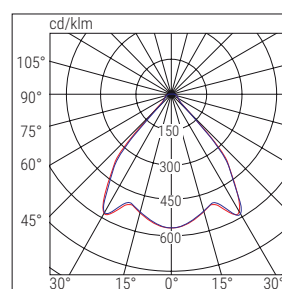

■ C0-C180  
■ C90-C270

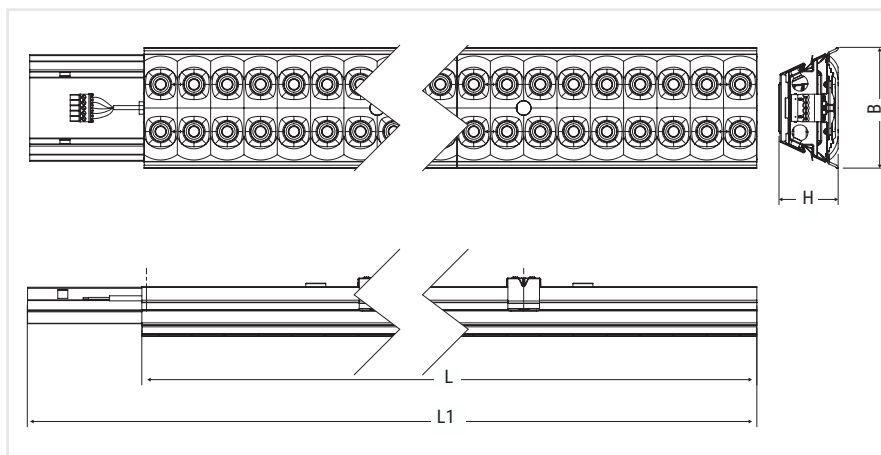

### NUMBER OF LAMPS IN CONTINUOUS ROW PER PHASE

Size	No. of lamps 230VAC	Cable cross-section mm <sup>2</sup>	Line length m 230VAC
S	-	2.5	-
M	46	2.5	52
L	37	2.5	52

Size	Dimensions mm			
	L	L1	B	H
S	569	719	114	56
M	1138	1288	114	56
L	1422	1572	114	56

	Size	Order Code	Description	Power W	Colour temp. K	Chromatic yield	LED Flux lm (Tj=25°C)	Luminaire flux lm	Brightness efficiency lm/W	Weight Kg	Packaging Single/ Multi pack	Notes and compliance
<b>SD</b>	S	<b>LF218SD*</b>	LENS FILA LED 2x18 SD 4K	30	4000	≥80	4700	4000	133	1.3	1	
	M	<b>LF236SD</b>	LENS FILA LED 2x36 SD 4K	60	4000	≥80	9300	8000	133	2.5	1	
	L	<b>LF280SD</b>	LENS FILA LED 2x80 SD 4K	74	4000	≥80	11600	9900	134	3.5	1	
<b>ED</b>	S	<b>LF218ED*</b>	LENS FILA LED 2x18 ED 4K	27	4000	≥80	4200	3600	134	1.3	1	
	M	<b>LF236ED</b>	LENS FILA LED 2x36 ED 4K	54	4000	≥80	8600	7300	136	1	1	
	L	<b>LF280ED</b>	LENS FILA LED 2x80 ED 4K	67	4000	≥80	10500	9000	135	1	1	
<b>DALI</b>	<b>INTERFACING WITH ACCESSORY TO BE ORDERED SEPARATELY:</b> It is possible to create DALI luminaires by integrating the version <b>SD</b> with the accessory <b>Dali Module</b> Order Code <b>15024</b> Example: Order Code <b>LF218SD+ 15024</b> = Luminaire <b>LF218SD</b> in the <b>DALI</b> version											

\* Products can be installed ONLY at the beginning of a row and ALWAYS with code 20138 - NOT with codes 20126 and 20134

## ACCESSORIES - included



**SMART DIMMER LIGHT SENSOR**

Order Code **15039**





## BUILDING AUTOMATION - to be ordered separately



**LOGICA SD LGFM CONTROL UNIT**



Order Code **21102**

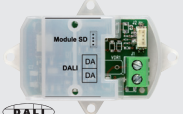





**DALI MODULE**

Order Code **15024**



**BUILDING AUTOMATION RADIO MODULE**

Order Code **15022**





**1÷10V MODULE**

Order Code **15034**





**BUILDING AUTOMATION RADIO TRANSMITTER**

Order Code **20104**



## ACCESSORIES - to be ordered separately

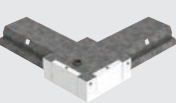

**JUNCTION BOX**

Order Code **20126**

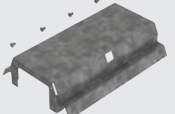

**JUNCTION BOX BRACKET**

Order Code **20134**



**SUSPENDED MOUNTING KIT**

Order Code **20127** (1,5m)  
Order Code **20133** (3m)



**POWER SUPPLY END CAP**

Order Code **20138**

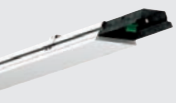

**5-POLE DUMMY MODULE**

Order Code **20135** (600mm)  
Order Code **20136** (1200mm)  
Order Code **20137** (1500mm)

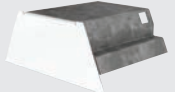

**END CAP**

Order Code **20139**



**5-PIN CONNECTOR F 90° L1 N L2 T L3**

Order Code **20141** (male)  
Order Code **20140** (female)



**5-POLE CONNECTOR F-DP 90° L1 N L2 T L3**

Order Code **20142** (female)

NEXT >

# Lens Fila

lighting

## ACCESSORIES - to be ordered separately



**CABLE WITH 5-PIN F-CONNECTOR**

Order Code **20144** (female)

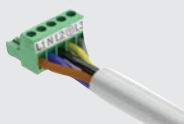

**CABLE WITH 5-PIN M/F CONNECTOR**

Order Code **20146** (male-female)



**CABLE WITH 5-PIN DOUBLE F CONNECTOR**

Order Code **20145** (female)



**CABLE WITH 5-PIN CONNECTOR 2X F/F**

Order Code **20147** (female-female)

## LED INVERTER EMERGENCY LUMINAIRE - to be ordered separately



**INVERTER PLUG&LIGHT SE/SA 1-3h 20-60V**

Order Code **19358** (1h)  
Order Code **19359** (3h)

**TR**



**INVERTER GL AT/LG AR 15W 55V**

Order Code **19391** (LiFe battery)  
Order Code **19390** (LTO battery)

**AT LG**



**INVERTER AT/LG AR 9W 55V**

Order Code **19355L** (LiFe battery)

**AT LG**



**LGFM EMERGENCY MODULE**  
For AT/LG series inverters only

Order Code **19375**

**LGFM**

## COMPONENTS REQUIRED FOR DIFFERENT MOUNTING CONFIGURATIONS

Single luminaire powered from one side

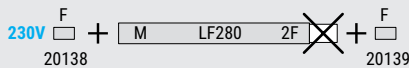

Single luminaire powered from above

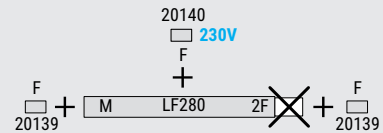

"T" configuration powered from one side

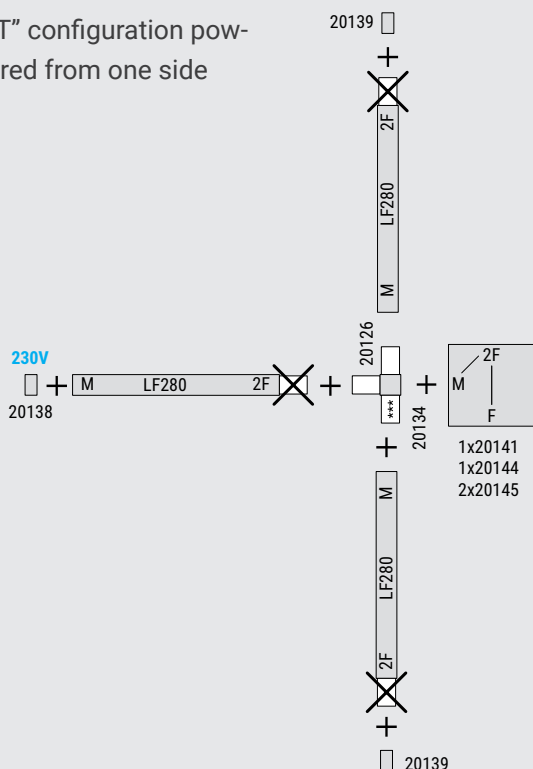

"T" configuration powered by the junction box

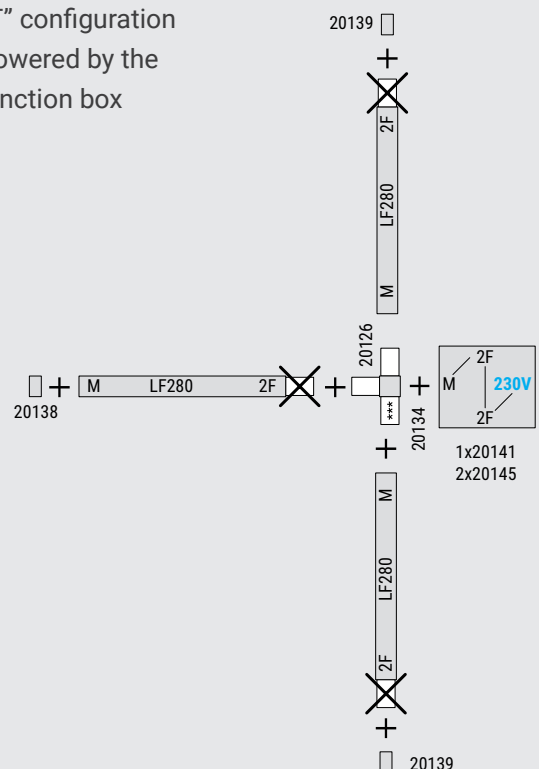

### In-line configuration powered from one side

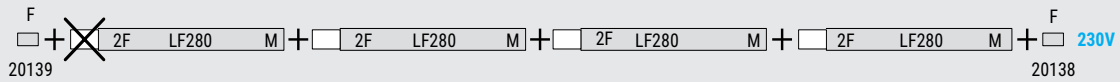

### In-line configuration powered from above

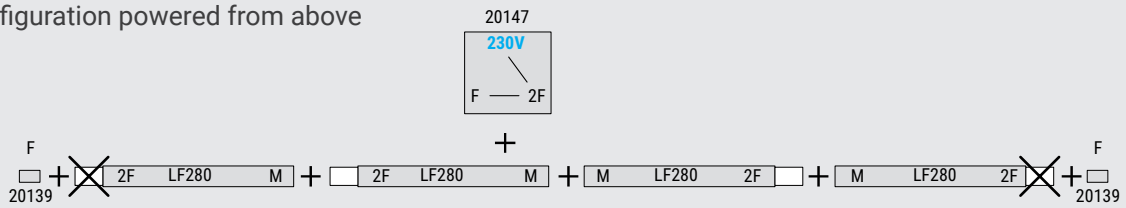

### "L" configuration powered from one side

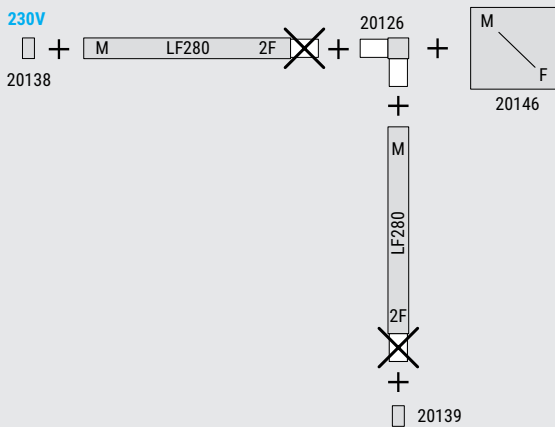

### "L" configuration powered by the junction box

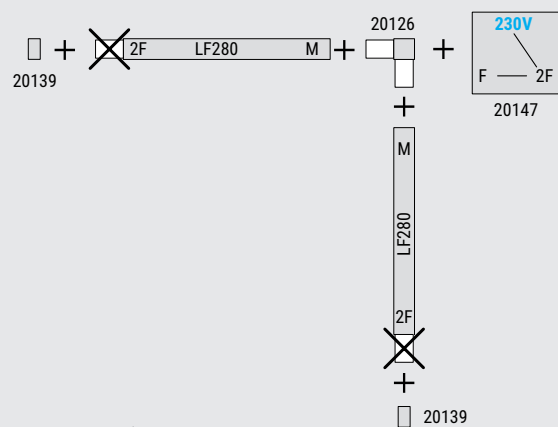

### "X" configuration powered from one side

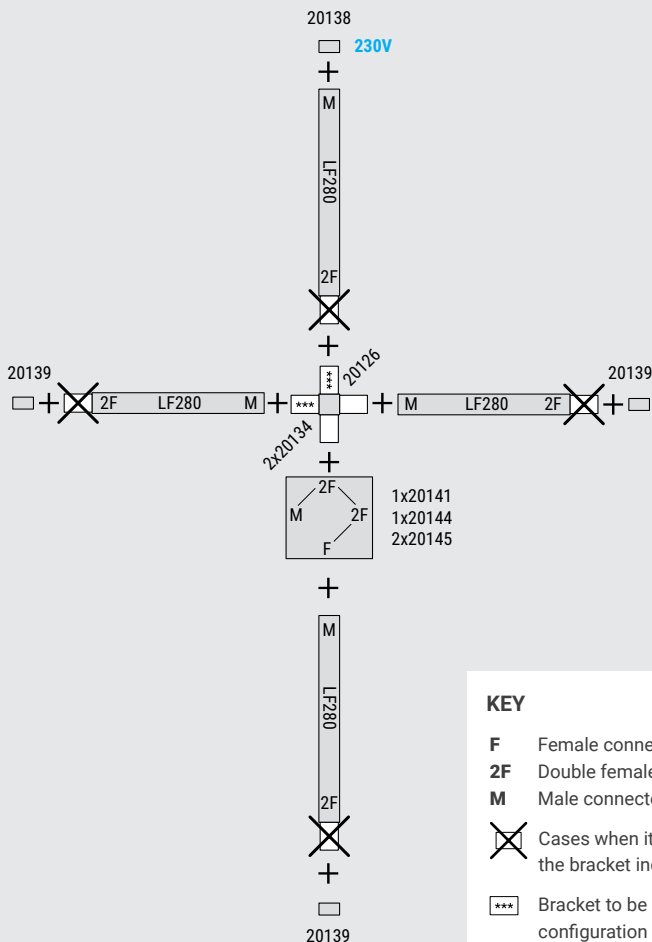

### "X" configuration powered by the junction box

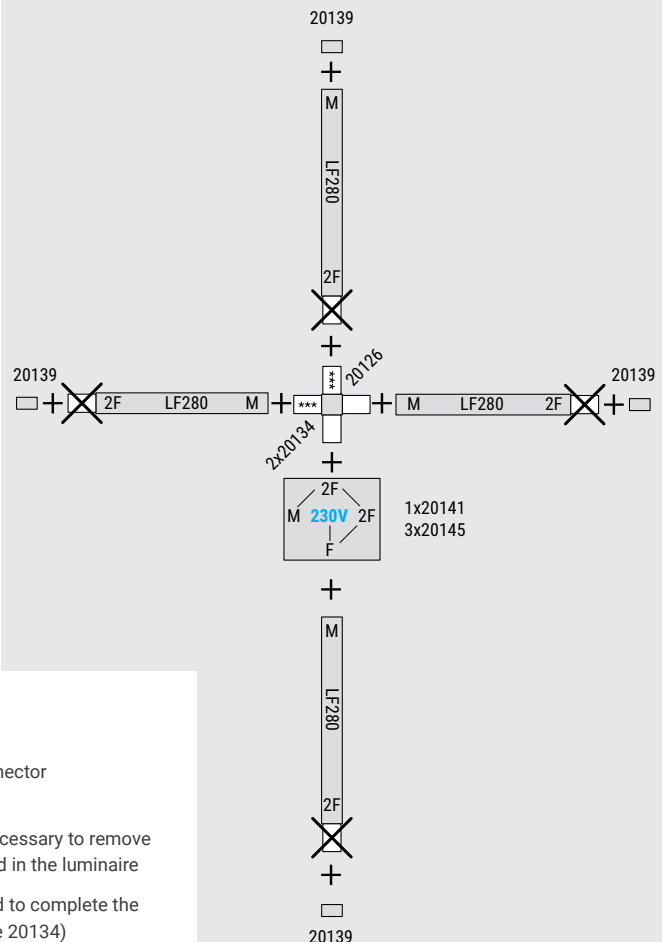

#### KEY

- F** Female connector
- 2F** Double female connector
- M** Male connector
- Cases when it is necessary to remove the bracket included in the luminaire
- Bracket to be added to complete the configuration (Code 20134)