



QUADER

Square housing with cuboid-shaped opal cover. Single, double, or triple-sided escape route signage is provided thanks to self-adhesive films.

Versions for ceiling mounting or with additional equipment for wire or rod suspension mounting and chain/cable mounting

MOUNTING OPTIONS

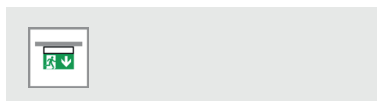

MOUNTING OPTIONS WITH EQUIPMENT



TECHNICAL DATA

Housing: Sheet steel, white (RAL 9003)
Cover: Methacrylate, opal

Service life $L_{50}B_{50}$: 50.000 h
Color stability: 3 SDCM



SELF-CONTAINED SUPPLY

Mains supply: 198 V–254 V/50 Hz
Specification: Maintained or non-maintained mode
Ambient temperature: LTO: -20 °C to +50 °C
 Classic 0 °C to +40 °C
Protection class: I

DECENTRAL SUPPLY

Battery supply: 24 V +/- 20% DC
Mains supply: 24 V +/- 20% DC
Ambient temperature: -20 °C to +40 °C
Protection class: III



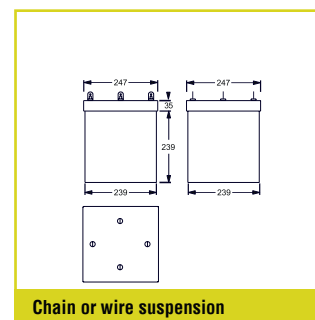
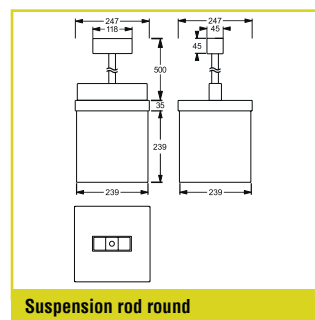
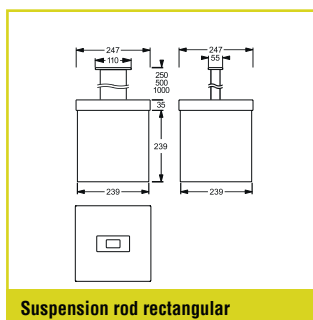
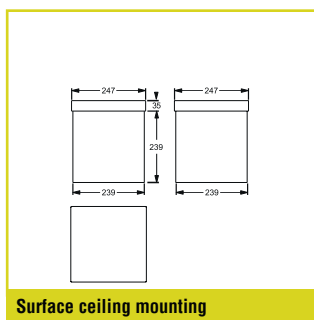

CENTRAL SUPPLY

Battery supply: 176 V–276 V
Mains supply: 198 V–254 V/50 Hz
Ambient temperature: -20 °C to +40 °C
Protection class: I













SELF-CONTAINED SUPPLY

| Autotest Order code | Logica Order code | Logica FM Order code |  |  |  |  |  |
|---|----------------------|-------------------------|---|---|--|---|---|
| Surface ceiling mounting, suspension, chain or wire suspension (3-sided escape route lighting) ¹ | | | | | | | |
| 37072 | 37073 | 37074 | 22 m / 44 m | 2 | 1 h / 3 h / 8 h | 2 x LTO 7.2 V / 0.5 Ah | 4.85 VA |





CLASSIC SELF-CONTAINED SUPPLY

| Autotest Order code | Logica Order code | Logica FM Order code |  |  |  |  Autotest |  Logica |  |
|---|----------------------|-------------------------|---|---|---|---|--|---|
| Surface ceiling mounting, suspension, chain or wire suspension (3-sided escape route lighting) ¹ | | | | | | | | |
| 36084 | 36085 | 36086 | 22 m / 44 m | 2 | 1 h / 3 h | NiMh 7.2 V / 0.6 Ah | NiMh 7.2 V / 1.2 Ah | 10 VA |





SICURO^{LED} DECENTRAL SUPPLY

| Sicuro24 Order code |  |  |  |
|---|---|---|---|
| Surface ceiling mounting, suspension, chain or wire suspension (3-sided escape route lighting) ¹ | | | |
| 32024 | 22 m / 44 m | 2 | 4.3 W |

SICURO^{LED} CENTRAL SUPPLY

| Sicuro230 Order code |  |  |  |  |
|---|---|---|---|---|
| Surface ceiling mounting, suspension, chain or wire suspension (3-sided escape route lighting) ¹ | | | | |
| 31024 | 22 m / 44 m | 2 | 9.4 VA / 4.7 W | |

¹ For surface mounting and all suspended versions, please order required equipment separately

| Please order exit sign equipment separately | | | |
|---|-------------|----------------|---|
| Order code | Description | | |
| VD 22 m | VD 44 m | | |
| F15330M | F15325M | Exit sign film |  |
| F15331M | F15326M | Exit sign film |  |
| F15332M | F15327M | Exit sign film |  |
| F15329M | F15328M | Exit sign film |  |

| Please order additional equipment separately | |
|--|--------------------------------------|
| Order code | Description |
| F95210 | Adapter for suspension rod |
| F95600 | Suspension rod, rectangular, 250 mm |
| F95601 | Suspension rod, rectangular, 500 mm |
| F95400 | Suspension rod, round, 500 mm |
| F95406 | Adapter for chain or wire suspension |