

Instruction manual

Atomic LED

   230V/50Hz

BEGHELLI - ELPLAST, a.s.
 Poříčí 3A, 603 16 Brno - CZ
 Tel: (+420) 531 014 111
 Fax: (+420) 531 014 210
 beghelli@beghelli.cz, www.beghelli.cz



DIMENSIONS

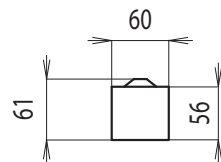
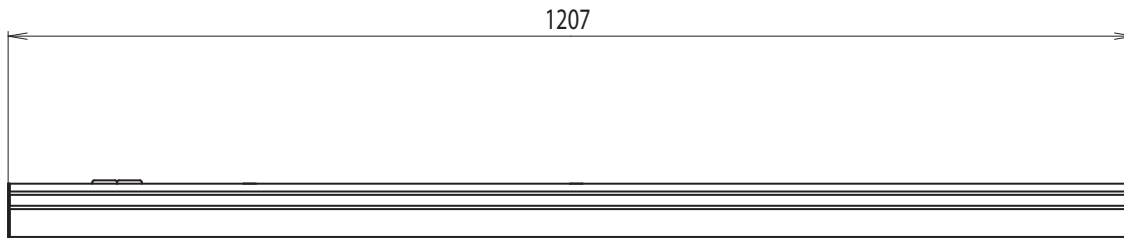

Dimension 61 mm is valid only for surfaced versions

IMAGE - 1

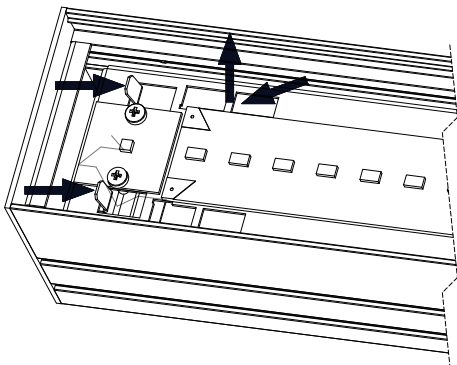

IMAGE - 2



MOUNTING PROCEDURE

1) REMOVING REFLECTOR



2) PREPARATION OF SCREWS AND DIST. INSERTIONS

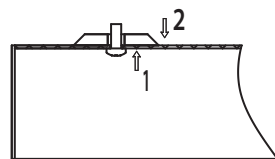

3) MOUNTING HOLES

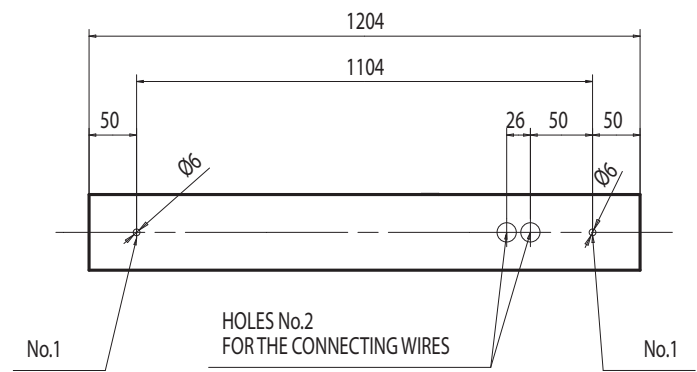

HOLES No.1 - FOR MOUNTING:
 ON WALL/CEILING, SUSPENDED MOUNTING, ON RECESSED FRAME
 HOLES No.1 DIAMETER

4) PREPARATION OF CONNECTING PART

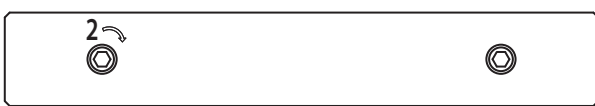

5) MOUNTING OF ENDING

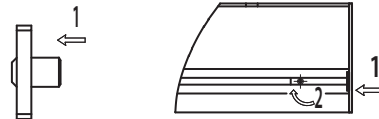

6) FITTING COUPLING PART TO PROFILE

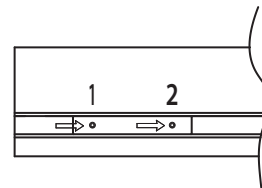

7) LUMINAIRE CONNECTION WITH COUPLING PART

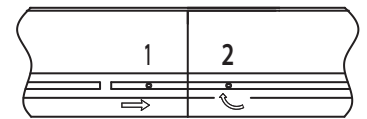

8) ASSEMBLY OF HINGE ON LUMINAIRE

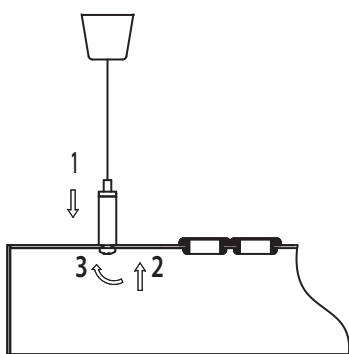

9) MOUNTING HOLE

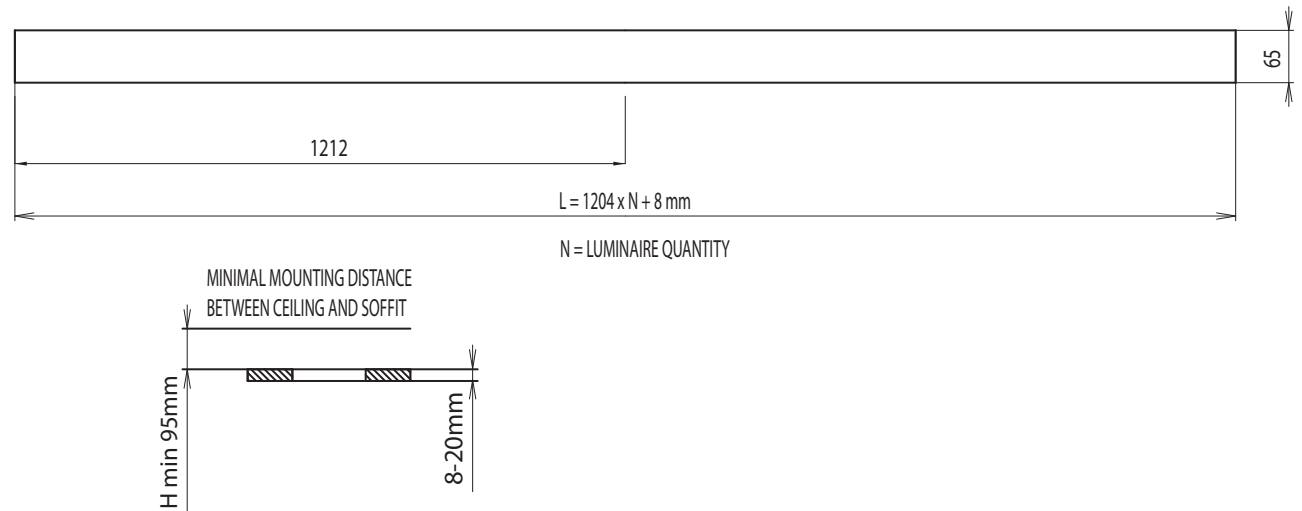

10) MOUNTING OF ENDING

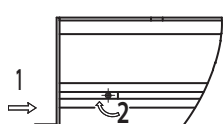

11) ASSEMBLY OF RECESSED LUMINAIRE

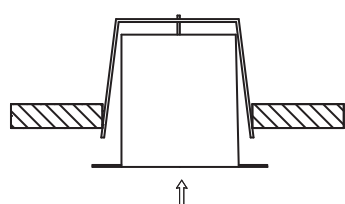

12) EXPAND THE SPRINGS

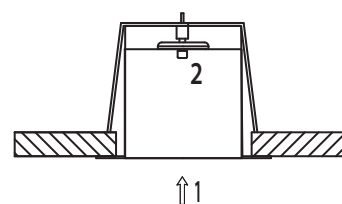

Instruction manual

Atomic LED

   230V/50Hz

BEGHELLI - ELPLAST, a.s.
Poříčí 3A, 603 16 Brno - CZ
Tel: (+420) 531 014 111
Fax: (+420) 531 014 210
beghelli@beghelli.cz, www.beghelli.cz



MOUNTING PROCEDURE:

For handling reflector and diffuser use enclosed gloves

CEILING MOUNTING - SEPARATE

Remove the cover using the supplied tool (see IMAGE-1) and the reflector (Fig.1) from the luminaire. Lead the wire through the hole for the cable. Prepare the screw and the insertion (Fig.2). Attach the luminaire with screws into pre-drilled holes (Fig.3) and connect the cables to the terminal located on the beam. Assembly the reflector in reverse order than shown in the Fig.1. Mount back the cover (see IMAGE-2).

CEILING MOUNTING - COUPLING IN LINES

Remove the covers using the supplied tool (see IMAGE-1) and the reflectors (Fig.1) from the luminaires. Then prepare the clutch (Fig.4) and assembly the ending 99-0123 on the first and the last luminaire in the line (Fig.5). Then assembly the clutch into profile (Fig.6). Pass the wire through the hole. Prepare the screw and the insertion (Fig.2). Attach the luminaires with screws into pre-drilled holes (Fig.3) and connect them to each other (Fig.7). Lead the power cable to the terminal box located on the beam and then interconnect all the luminaires with wire required length and corresponding cross-section. Assembly the reflector in reverse order than shown in the Fig.1. Mount back the covers (see IMAGE-2).

PENDANT MOUNTING - SEPARATE

Remove the cover using the supplied tool (see IMAGE-1) and the reflector (Fig.1) from the luminaire. Assembly the pendant 99-0085 into pre-drilled holes (Fig.3). Attach the luminaire to pendant 99-0085 with screws M4 (Fig.8). Lead the power cable the hole and connect it to the terminal block located on the beam. Assembly the reflector in reverse order than shown in the Fig.1. Mount back the cover (see IMAGE-2).

PENDANT MOUNTING - COUPLING IN LINES

Remove the covers using the supplied tool (see IMAGE-1) and the reflectors (Fig.1) from the luminaires. Then prepare the clutch (Fig.4) and assembly the ending 99-0125 on the first and the last luminaire in the line (Fig.5). Then assembly the clutch into profile (Fig.6). Assembly pendants 99-0096 into pre-drilled holes (Fig.3). Attach the luminaires to pendant 99-0096 by screws M4 (Fig.8) and connect them to each other (Fig.7). Pass the wire 99-0094 or 99-0095 through the hole and plug in the terminal box located on the beam. Then interconnect all the luminaires with wire required length and corresponding cross-section. Assembly the reflector in reverse order than shown in the Fig.1. Mount back the covers (see IMAGE-2).

RECESSED MOUNTING - SEPARATE

Remove the cover using the supplied tool (see IMAGE-1) and the reflector (Fig.1) from the luminaire. Attach endings for recessed mounting (Fig.10). Attach the luminaire (Fig.11) into mounting hole (Fig.9) and then expand the springs by tightening the screw. Lead the power cable through the hole and connect it to the terminal block located on the beam. Assembly the reflector in reverse order than shown in the Fig.1. Mount back the cover (see IMAGE-2).

RECESSED MOUNTING - COUPLING IN LINES

Remove the covers using the supplied tool (see IMAGE-1) and the reflectors (Fig.1) from the luminaires. Then prepare the clutch (Fig.4) and assembly into profile (Fig.6). Assembly the ending 99-0124 on the first and the last luminaire in the line (Fig.10). Attach the luminaires (Fig.11) into mounting hole (Fig.9). Expand the springs by tightening the screw. Then connect the luminaires (Fig.7). Plug the power cable into terminal box located on the beam and interconnect all the luminaires with wire required length and corresponding cross-section. Assembly the reflector in reverse order than shown in the Fig.1. Mount back the covers (see IMAGE-2).

TECHNICAL DETAILS:

- Rated voltage: 230V, 50Hz
- Light source: LED
- Degree of protection: IP 40
- Electrical accident protection class: I
- Suitable for direct mounting onto a normally inflammable basis - F: yes
- The luminaire satisfies requirements of all standards in force

WARNING:

- Check whether the mains specification satisfies the data mentioned on a luminaire plate before connecting it to the mains.
- Contact the customer service authorised centre for replacement of fluorescent tubes and batteries and for repairs, and insist on using original spare parts only. Not satisfying these instructions could result in loss of luminaire safety or in loss of warranty.
- This luminaire should only be used for a purpose for which it was manufactured. Any other usage shall be assumed to be unsuitable and therefore dangerous. The manufacturer bears no responsibility for any injury caused to persons or animals or for property damages caused by improper, faulty or inadequate usage.
- A luminaire must be disconnected from the mains before any interference with a luminaire, service or maintenance. An expert person, in terms of valid regulations concerning the competence to activities, should only perform these actions.
- The luminaire may only be connected to the mains, whose installation and protection satisfies standards in force.

WARRANTY:

All products of the company Beghelli - Elplast, a.s. are made of the highest quality materials, thoroughly tested and guaranteed by the manufacturer to be free of defects in terms of existing legislative regulations. This warranty becomes invalid if mounting is not executed according to the instruction manual, the luminaire is damaged or modified or repaired by an unauthorised service centre of the company Beghelli - Elplast, a.s.

The product cannot be disposed as unsorted municipal waste. It must be collected separately to prevent negative environmental impacts. In accordance with the procedures of Directive 2002/96 and relevant national laws and regulations adopted pursuant to this Directive on the disposal of waste at the end of the life cycle of the product, any violation is sanctioned by law. Please inform yourself about the local separate collection system for electrical and electronic products.

